



Server Series



STATIC LOADING CAPACITY

1500KG

Server Series



Standard

- Comply with ANSI/EIA, RS-310-D; IEC297-2; DIN41491: PART 1; DIN41491: PART 7; GB/T3047.2-92 standard, compatible with 19" international standard, metric system and ETSI standard

Features

- Reliable structure, static loading capacity: 1500KG
- Adjustable feet and castors options are available
- Baying cabinets together easily
- Double mesh front door & rear door, steel rear door
- Top and bottom cable entries
- Front door, rear door and side panel can be easily removed
- Front & rear door with spring lock
- Optional accessories

Materials

- SPCC cold rolling steel plate
- Mounting profile thickness : 2.0mm ; Others: 1.2mm



U numbered mounting rail



Wide angle door hinge



Spring Lock



Grounded terminal

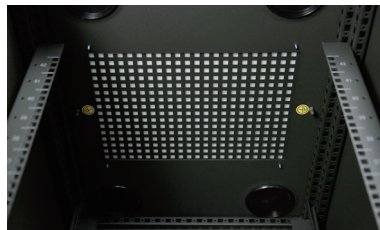

Top panel

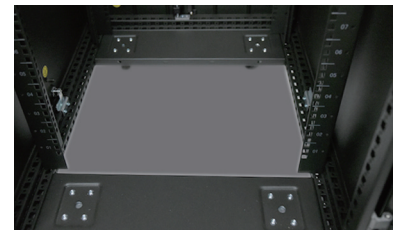

Open bottom for easy cable management

Specifications subject to change without notice.

Eight Limited

No.18, 4/F., Thriving Industrial Centre, 26-38 Sha Tsui Road, Tsuen Wan, N.T., Hong Kong
Tel: (852) 2413 2222

Fax: (852) 2411 3000

Email: info@eightgroup.com



Visit us at Website

<http://www.eightgroup.com>

Server Series



Mesh Double Door



Side Panel



Back Door

Sever Cabinet				
Model	Capacity (U)	Width (mm)	Depth (mm)	Height (mm)
2268ST-E	22	600	800	1180
2260ST-E	22	600	1000	1180
2768ST-E	27	600	800	1405
2760ST-E	27	600	1000	1405
3268ST-E	32	600	800	1630
3260ST-E	32	600	1000	1630
3768ST-E	37	600	800	1855
3760ST-E	37	600	1000	1855
4268ST-E	42	600	800	2080
4260ST-E	42	600	1000	2080
4261ST-E	42	600	1100	2080
4280ST-E	42	800	1000	2080
4281ST-E	42	800	1100	2080
4760ST-E	47	600	1000	2280
4761ST-E	47	600	1100	2280
4780ST-E	47	800	1000	2280
4781ST-E	47	800	1100	2280

*Height Include Castor

Specifications subject to change without notice.

Eight Limited

No.18, 4/F., Thriving Industrial Centre, 26-38 Sha Tsui Road, Tsuen Wan, N.T., Hong Kong
 Tel: (852) 2413 2222 Fax: (852) 2411 3000 Email: info@eightgroup.com



Visit us at Website
<http://www.eightgroup.com>

Dimensions

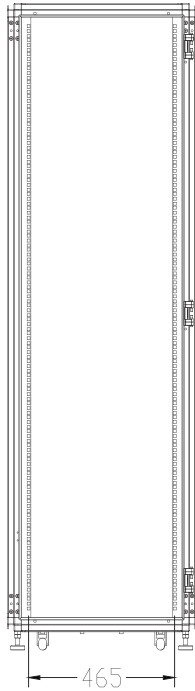

FRONT VIEW
(without door)

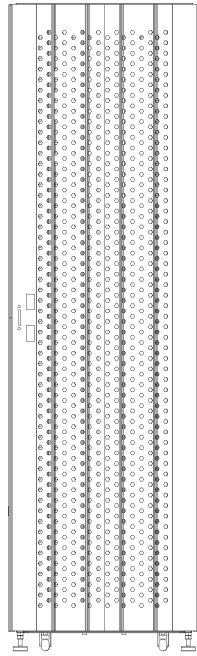

FRONT VIEW
(with door)

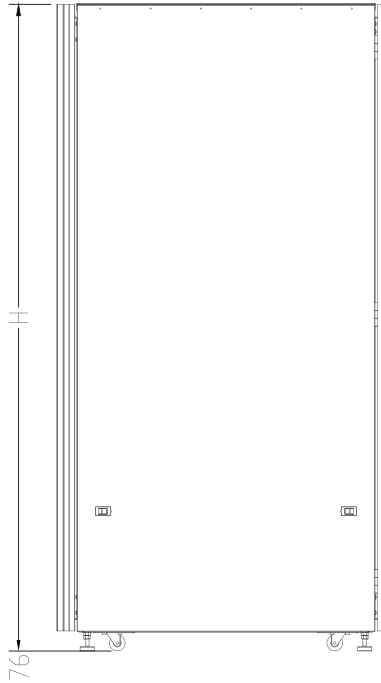

SIDE VIEW

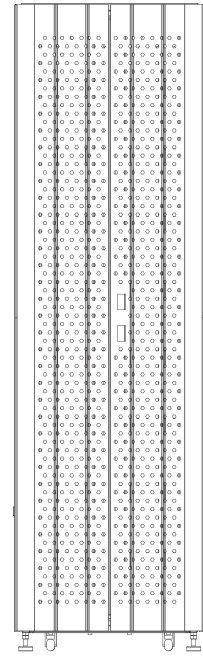

BACK VIEW

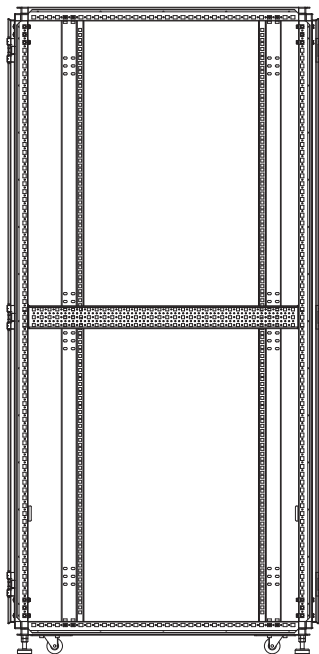

INNER STRUCTURE

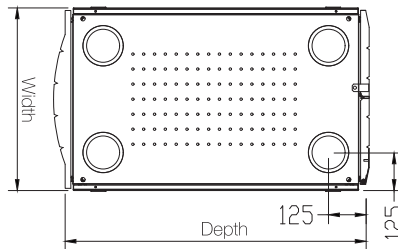

TOP VIEW
(with cover)

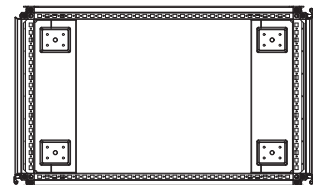

TOP VIEW
(without cover)

Specifications subject to change without notice.

Eight Limited

No.18, 4/F., Thriving Industrial Centre, 26-38 Sha Tsui Road, Tsuen Wan, N.T., Hong Kong
Tel: (852) 2413 2222 Fax: (852) 2411 3000 Email: info@eightgroup.com



Visit us at Website
<http://www.eightgroup.com>

Structure Diagrams

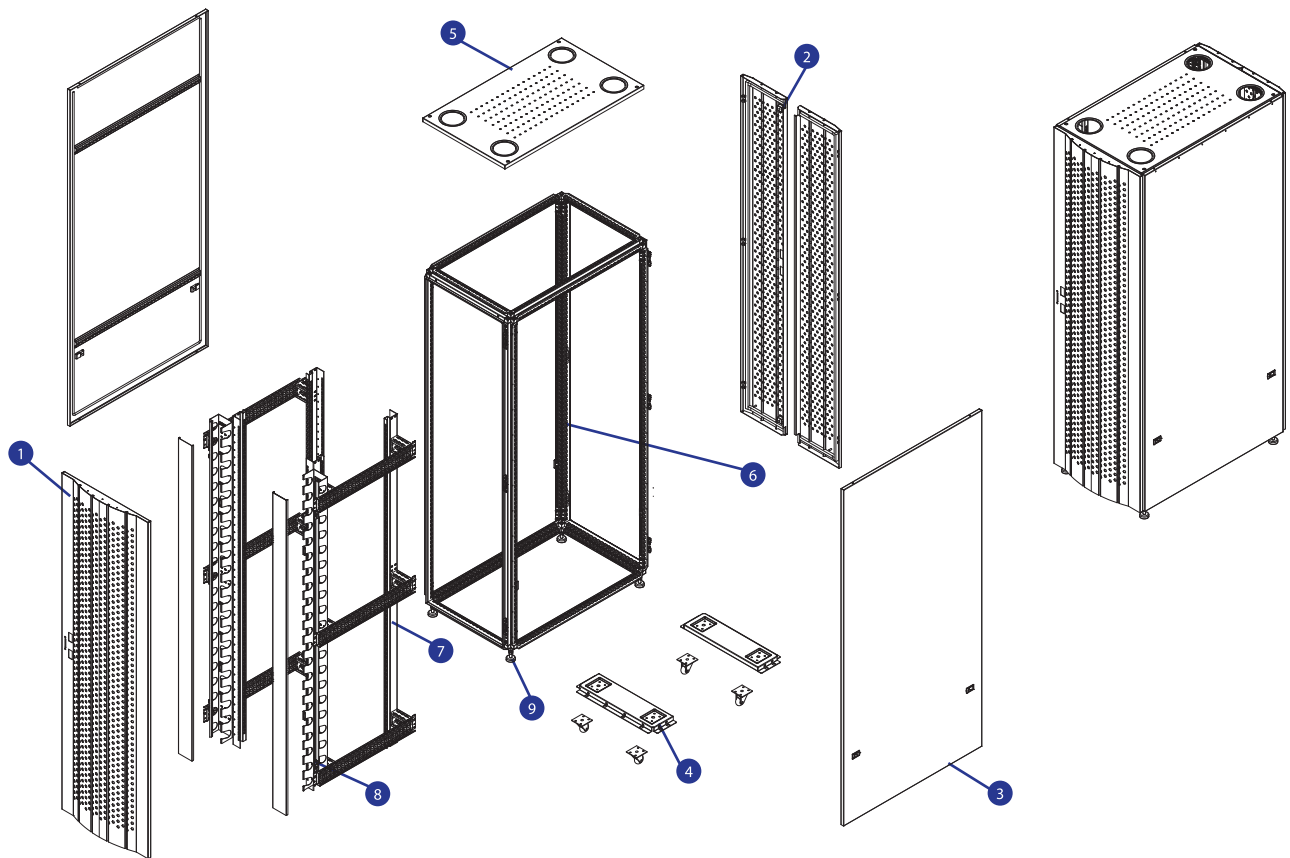

Server Network Cabinet

Number	Name of Parts	Quantity	Unit	Remark
1	Front door	1	Piece	SPCC cold rolling steel plate
2	Rear Door	1	Piece	SPCC cold rolling steel plate
3	Side Panel	2	Piece	SPCC cold rolling steel plate
4	Bottom	2	Piece	SPCC cold rolling steel plate
5	Top Cover	1	Piece	SPCC cold rolling steel plate
6	Frame	1	Piece	SPCC cold rolling steel plate
7	Mounting Profile	4	Piece	SPCC cold rolling steel plate
8	Cable Manager	2	Piece	for 800 width cabinet only
9	Adjustable Feet	4	Piece	---
10	Castor	1	Set	---
11	Lock	1	Piece	Zinc alloy
12	Key	2	Piece	---
13	M6 Screw	1	Set	---

Specifications subject to change without notice.

Eight Limited

No.18, 4/F., Thriving Industrial Centre, 26-38 Sha Tsui Road, Tsuen Wan, N.T., Hong Kong

Tel: (852) 2413 2222

Fax: (852) 2411 3000

Email: info@eightgroup.com



Visit us at Website

<http://www.eightgroup.com>